

SPECIFICATIONS

Loudspeaker Type:	Two-way, full-range, bass ported stage monitor
Operating Range:	55 Hz to 18 kHz 80 Hz to 16 kHz (±2 dB)
PASSIVE MODE SPECIFICATIONS	
Max Input (Passive):	300W continuous, 750W program 49 volts RMS, 110 volts momentary peak
Recommended Power Amplifier:	630W to 900W @ 8 ohms
Sensitivity(1W/1m):	97 dB SPL (100 Hz to 16 kHz 1/3 octave bands) 98 dB SPL (250 Hz to 4 kHz speech range)
Maximum Output:	122 dB SPL / 129 dB SPL (peak)
Nominal Impedance:	8 ohms
Minimum Impedance:	5.3 ohms @ 1.9 kHz
BI-AMP MODE SPECIFICATIONS	
Max Input (Bi-amp):	LF - same as for passive mode HF - 80W continuous, 160W program 25 volts RMS, 51 volts momentary peak
Recommended Power Amplifier:	LF - same as for passive mode HF - 130W to 190W @ 8 ohms
Sensitivity (1W/1m):	LF - 99 dB SPL (100 Hz to 1600 Hz 1/3 octave bands) HF - 106 dB SPL (2 kHz to 16 kHz 1/3 octave bands)
Maximum Output:	124 dB SPL / 131 dB SPL (peak)
Nominal Impedances:	LF - 8 ohms HF - 8 ohms
Crossover Frequency:	1.5 kHz
Recommended Signal Processing (bi-amp):	60 Hz high pass filter
M12 MONITOR SPECIFICATIONS	
Nominal -6dB Beamwidth:	40-90° H x 70° V
Axial Q / DI:	7.1 / 8.5, 1.5 kHz to 12.5 kHz
Recommended Signal Processing:	60 Hz high pass filter
Drivers:	LF 1 x 12" Ferrofluid-cooled HF 1 x 2" exit B&C DE85
Driver Protection:	None
Input Connection:	(2) Neutrik NL4MP
Controls:	Bi-amp/Passive switch
Enclosure:	Multilayer glass composite
Grille:	18-gauge perforated steel
Required Accessories:	DSP for bi-amp operation
Supplied Accessories:	None
Optional Accessories:	M12-RDCASE2 roadcase for two M12 monitors M12-RDCASE4 roadcase for four M12 monitors
Dimensions - Height:	10.5 inches (266.7 mm)
Width:	21.5 inches (546.1 mm) - widest point
Depth:	20.75 inches (527.1 mm)
Weight:	56 lbs (25.4 kg)
Shipping Weight:	73 lbs (33.1 kg)

NOTES:

- Sensitivity (passive): Free field pink noise measurement at 10 ft (3 m) at 65% power; extrapolated to 1 meter and an input of 2.83 volts RMS.
- Sensitivity (bi-amp): Free field pink noise measurement at 12 ft (3.7 m) at 65% power; extrapolated to 1 meter and an input of 2.83 volts RMS.
- Watts: All wattage figures are calculated using the rated nominal impedance.



APPLICATIONS

- Televised live events
- Live stage and small theatre events
- Corporate events
- Conference rooms
- Houses of worship
- Auditoria, lecture halls

FEATURES

- Low profile, high style exterior with small footprint
- Multilayer glass composite construction
- Non-reflective black or white exterior with matching heavy-duty non-reflective grille
- Ergonomic rubber pocket grip handles
- High powered, 12-inch woofer
- 2-inch wide-band compression driver on an asymmetrical horn
- Switchable bi-amp/passive configuration with well protected dual NL4 connectors
- Available in mirror right or left horn configurations
- Five-year warranty

DESCRIPTION

The M12 stage monitor system is a high style, no-compromise solution to the demands of high performance monitoring. At 10 1/2" high, the M12 offers clean sightlines for the audience and the camera. The rugged multilayer glass composite construction, "Texas Boot-proof" stainless steel grille and an abrasion resistant non-reflective finish make the M12 an excellent choice for TV broadcasts and stage productions. The dual NL4 connectors are tucked safely away in a pocket beneath the M12. Specially molded channels and cable clips allow the user to bring the speaker cables out of the back or either side of the monitor. These exits also allow easy positioning of the monitor. The M12 contains a high-powered 12" woofer and a 2" exit B&C wide band high frequency driver. The high frequency driver is mounted to a molded one-piece asymmetrical horn with a 90-degree pattern at the top and 40 degree at the bottom, allowing full-range monitor output close up or at a distance.

M12 OPTIONS

M12R-BP	HF horn molded to the "Right" of the LF driver, Black finish, Portable with built-in handles
M12L-BP	HF horn molded to the "Left" of the LF driver, Black finish, Portable with built-in handles
M12R-WP	HF horn molded to the "Right" of the LF driver, White finish, Portable with built-in handles
M12L-WP	HF horn molded to the "Left" of the LF driver, White finish, Portable with built-in handles

FREQUENCY RESPONSE (PASSIVE)

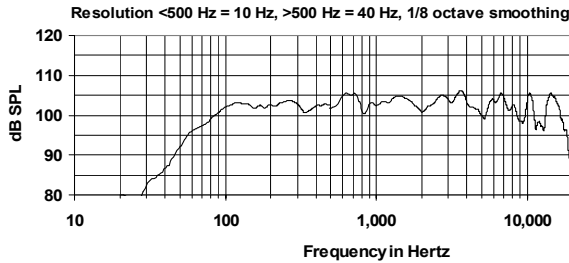

IMPEDANCE (PASSIVE)

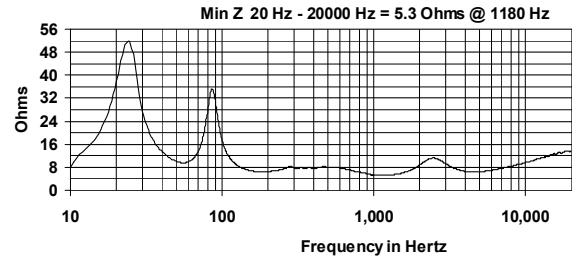

FREQUENCY RESPONSE (BI-AMP)

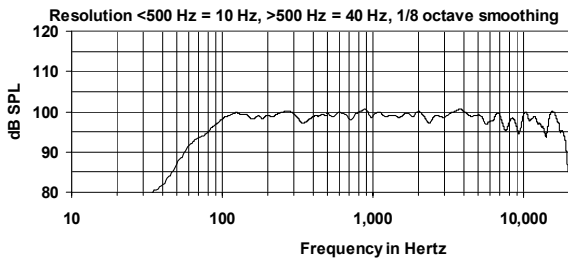

IMPEDANCE (BI-AMP)

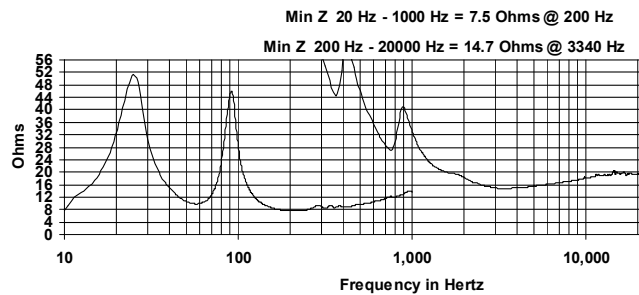

DIMENSIONS

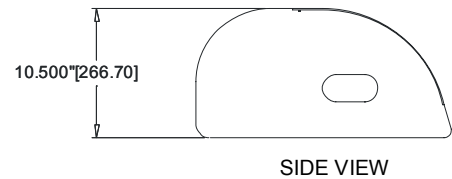
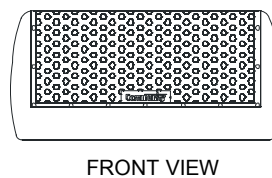
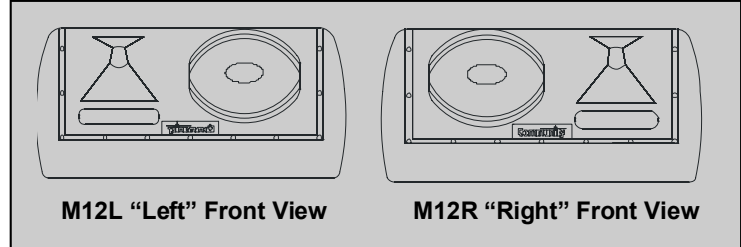
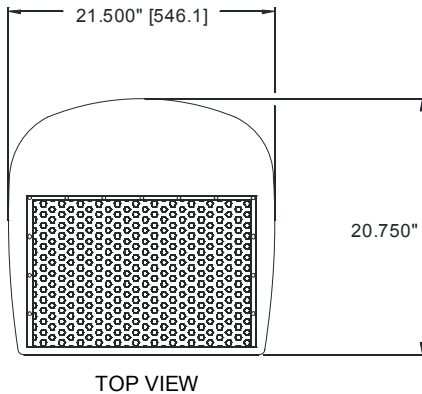

ARCHITECTURAL SPECIFICATIONS

The loudspeaker system shall be a two-way, full-range stage monitor design with one 12-inch woofer and one 2-inch exit HF driver mounted to a 40-90° H x 70° V molded horn. There shall be two NL4MP locking connectors. The loudspeaker enclosure shall be multilayer glass composite construction in a non-reflective black or white finish, with a matching non-reflective 18-gauge perforated steel grille. The system shall have an amplitude response of 55 Hz to 18 kHz (+/-2 dB), input capability of 49V RMS, 97 dB sensitivity at one meter and 2.83 V/8 ohms nominal impedance in the passive mode. The nominal dispersion shall be 40-90° H x 70° V. The loudspeaker shall be 10.5" (266.7 mm) H x 21.5" (546.1 mm) x W x 20.75" (527.1 mm) D and weigh 56 lbs (25.4 kg).